

THE TWINS

NA DAU VEIVAKADODONUTAKI



Na Pepa cakacaka ni Lotu vaka matavuvale

- NA VOSA NI KALOU -

“NA DAU VEIVAKADODONUTAKI”

Na Taro ni I Tubutubu

Na I Vukevuke ni Yavu ni vakabauta naba dua – Na Vosa ni Kalou

Nona na I Tubutubu (Tauri mai na I vola: God loves me 28 Ways for kids e vola ko Charles Mills & Linda Koh: GC CHM Department, tabana e 13)

- Na vosa oqo na 'Bible' se I Vola Tabu e tauri mai ena vosa vaka Kiriki na 'biblia' ka kena I balebale "na I vola" se "books."
- Na vei tamata duidui era vakaitavi ena kena volai na I Vola Tabu. E taura na loma ni gauna e tinikaono na drau (1600) na yabaki na kena volai.
- E tiko ena I Vola Tabu e ono sagavulu ka ono (66) na I Vola ka wasei vaka rua na veiyalayalati makawa kei na veiyalayalati vou.
- E tolusagavulu ka ciwa (39) taucoko na I vola ena veiyalayalati makawa ka ra volai ena vosa vaka Iperiu. E okati tiko eke na vola ni lawa, na I tukutuku makawa, na vosa vuku kei na serekali, na Parofita levu kei na Parofita lailai.
- Na Veiyalayalati Vou e tiko kina e ruasagavulu ka vitu (27) na I vola ka volai ena vosa vaka Kiriki. E okati eke na Kosipeli, na I tukutuku ni lotu kei ira na I vola ka vola ko Paula kei na parofisai.

Mo tekivu ena nomu vakananuma na I tinitini ni veika oqo

- *Na I tubutubu kei na gone me rau nanuma dei ni Kalou e buli keda ka bulia talega na vuravura. E kila deivaki tu o Koya na gaunisala uasivi me qaravi ka cakacaka kina na veika bula. Sa dodonu kina meda vakawilika matua na Nona I vola ni vakasala ka vakatokai tiko na I Vola Tabu. (kilai talega me Scripture - Vola Tabu, the Word- Na Vosa, Letter from God - I Vola mai Vua na Kalou). Na kena wiliki e veisiga na Vosa ka da talairawarawa ki na veika eda wilika sa na vukeyi keda me da kila na I tosotoso e na noda bula. (2 Timoci 3:16-17 [ICB] Na Kalou sa vakavuna na I Vola Tabu kecega a sa yaga oqo me I vakavuvuli, me vunauca na ca, me ia kina na vakadodonutaki, me ia kina na vakatavuvuli ena ka e dodonu: Me yaco kina na tamata ni Kalou me vakarau tu, ni sa vakarautaki ki nai valavala vinaka kecega., Na tamata e qarava na Kalou sa na vakarau tu, ena tu talega vua na veika e gadreva me vakayacora kina na cakacaka vinaka; Josua 1:8 [NLT] A I vola ni vunau oqo me kakua ni yali mai na gusumu. Ia mo vakanananu kina ena siga kei na bogi mo vakabauta kina mo cakava me vaka na ka kecega sa volai kina; ko na qai kalougata ena nomu I valavala, ia ko na qai tamata yaco.*

- *Na vei matavuvale me dau nanuma ni sa solia na I vakaro na Kalou meda kakua ni torova yani na veika dau veivakacacani se na tamata sa vakavu leqa se na veika tale eso eda sotava, oqori eda na vakila kina na marau tawa yalani kevaka eda digitaka me talairawarawa ki na Nona I vakasala kece. (Luke 11:28 A sa kaya ko koya, la sa kalougata vakalevu ko ira sa rogoca na vosa ni Kalou ka vakabauta! (Same 119:1-2) Sa kalougata ko ira era sa dodonu sara ena sala, Era muria na vunau I Jiova. Sa kalougata ko ira era vakabauta na nona vosa, Era qarai koya e na lomadra taucoko.)*
- *Na I tubutubu me I vakaraitaki vei ira na luvena na I tovo me dau wilika nona I vola tabu ena vei siga kei na kena bulataki na I vakavuvuli vakai vola tabu. Vakauasivi ena kena vakaraitaki oqori ena gaunisala era tuberi kina na luveda dau beci lewa ka talaidredre. (Vakarua 11:18-19 "Ia mo ni maroroya na noqu vosa oqo ena lomamuni kei na yalomuni, ka vauci me I vakatakilakila ena ligamuni, ka me sa kena I ukuuku e na maliwa ni matamuni. Ia mo ni vakavulica vei ira na luvemuni, ka dau vosataka ni kemuni sa tiko ena nomuni vale, ni kemuni sa lako voli talega ena sala, ni ko ni sa la'ki koto, ni kemuni sa duri cake talega.)*
- *Na I tubutubu sa na maroroya ka vaka bula na luvena kevaka e solia na gauna kei na nona I yau me vakavulica na luvena ena vei gaunisala kamikamica ni kena wiliki na vosa ni Kalou kei na kena bula taki ena veisiga.(2 Timoci 3:14-15 Ia ko iko mo tudei ena ka ko vakavulici kina , a ka sa vakadinadinataki vei iko, ni ko sa kila se ko cei sa vakatavulici iko. Ni ko sa kila nai Vola Tabu, niko a gone, oqori sa vakavukui iko rawa mo bula niko sa vakabauta Karisito Jisu; Vakaibalebale 22:6-7 Vakavulici ira na Luvemu me kila na duidui ni vinaka mai na ca se na dina mai na lasu. Nira sa yalomatua ka qase cake era na dau gumatua ena caka vinaka.)*

Kena Vakayagataki na vidio "Na Vuvale na "Tui" - Usutu ni SoKalou

- *Noda taura na gauna me vakawilika na I vola dusidusi ni kena tara e dua na ka se na kena vakayagataki e dua na I yaya vou ena vakagalala taki keda mai na leqa se rarawa eda na sotava mai muri. (O Sefa e sega ni via wilika na I vola dusidusi ni kena tara e dua na teveli ka vakavuna nona tara tu e dua na teveli malumalumu ka tatavukivuki rawarawa.) Ea qai tavuki na teveli oya ka loka era ka tasere talega na keke ni siga ni sucu nei Salome. E vaka kina na noda dau wilika vaka wasoma na vosa ni Kalou (O ya na I vola dusidusi ni Kalou kei na Nona I vola vei keda na noda Dau ni veibuli),sa na vukei keda ka maroroi keda mai na kavoro kei na rarawa ena noda bula.)*
- *Na I tubutubu kevaka e sega ni solia na veivakadonui ena so na gauna vua na luvena sa I vakaraitaki oqori ni nona loloma kei na nona veitaqomaki, o gone me dau vakarorogo ka talairawarawa vei rau nona I tubutubu. (O Marica e sega ni vakadonuya me vakayagataka o Salome na nona misini ni vakadodonutaki drau ni ulu. Na vuna oya ni kila o Marica ni sa ca tiko na misini ka na sega ni vukea me totoka na I rairai kei Salome ki na kanavata ni nona siga ni sucu. Nona talaidredre o Salome ki na I vakaro nei tinana e vakavuna me rairai lasa ka vakaloloma na drau ni uluna.)*

Na I tubutubu kei ira na luvena

Na taro me veivakananumi (Vakayagataka e rua me rawa ni vakaitavi kina na gone)

1. NANUMA LESU?

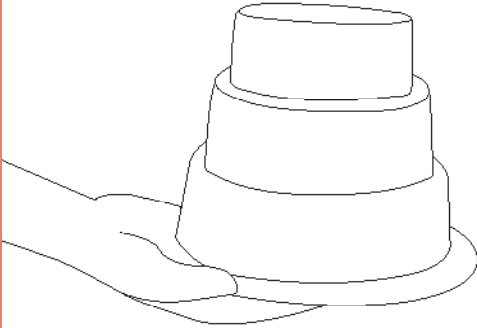

A

Na cava e a laveti mai na ovani ena I tekitekivu ni vidio? (e dua na keke taba tolu se bera ni ukutaki)

B

Cava e rua na I yaya ni cakacaka rau a vakayagataka tiko o Sefa kei Jonacani ena nodrau tara tiko na teveli ka sega ni vakamuraia na I vakasala rawarawa e tiko ena 'Allen Key' ka rau vakasalataki kina mai na I vola dusidusi ni caka teveli? (drill, blow torch, chainsaw,)jackhammer, nail gun)blow torch, chainsaw,) jackhammer, nail gun)

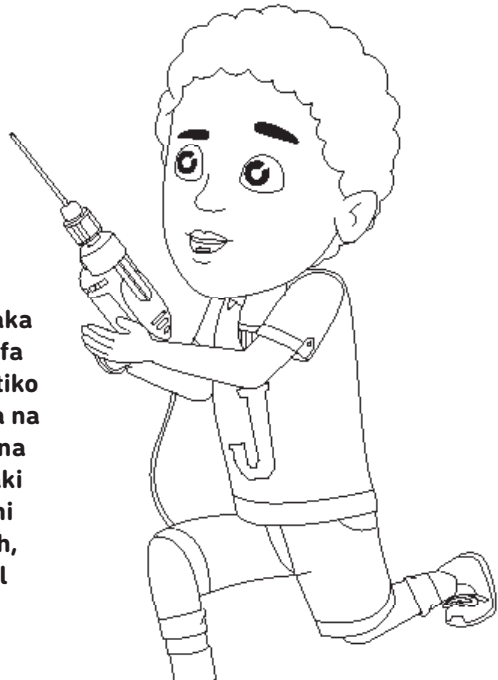

C Na cava rau rerevaka na drua ko Emeli kei Ema ni caka na pati?

Na rokaroka taki e rawa ni veivakayalovinaka taki ena gauna ni veitalanoa.



D Na cava e vakayagataka o Sefa ni sa dau boko vakasauri na cina? (2 cina tauri vakawaiwai)



E Na cava e yaco ki na teveli rau a tara o Sefa kei Jonacani? (Rau a coqa na drua ka vakavuna me bale raramusumusu ki ra ena gauna rau raica kina na drau ni ului Salome.)

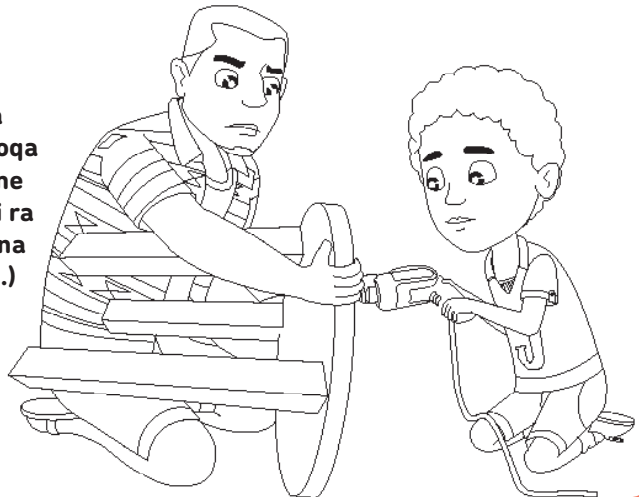

F E vakadodonu taka vakacava ko Sefa na kena tara cala tu na teveli ka vakavuna na lutu ni keke? (Rau a bole me rau qaqia na kirimu ni keke nei Salome ka vukeya sara me guileca na I rairai lasa ni nona ukutaki koya o Salome)

3. NANUMA BEKA?

A

Kea totoka na teveli
kevaka me vakamuria o
Sefa na I vakasala?

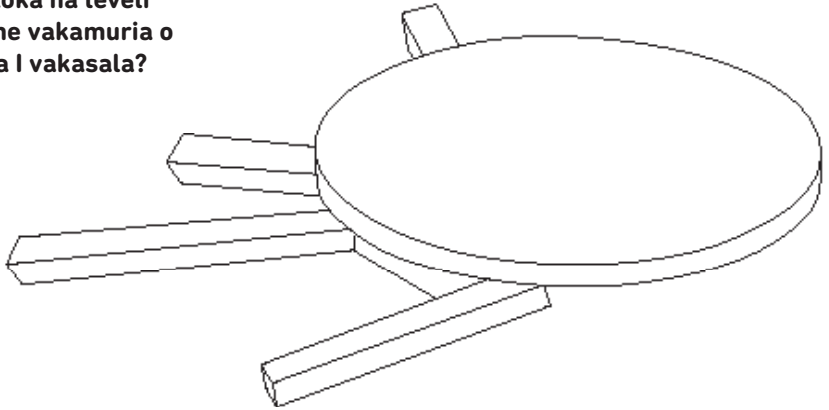

B

Sa donu tu vei Jonacani
me kua ni vakayagataki
na I vola dusidusi?



C

Sa rawa ni da vulica
na lesoni mai na
vidio oqo?



Masu ka kere veivosoti Vua na Kalou ena nomu sega ni dau solia na gauna mo wilika Nona Vosa ni vakadre oya na I Vola Tabu. Kerea me solia vei iko na kaukauwa mo talairawarawa vua na Yalo Tabu ka mo solia nomu gauna ena kena wiliki na Vosa ni Kalou ena veisiga.

- (A) (Io) Na cava mai na vidio e vakaraitaka oqo? (O Ema kei Emili ni dua talega na teveli vaka oya e tiko mai nodratou vale ia e balavu cake ka sega ni kama na yavana. Rau vakaibalebaletaka ni a tara na teveli ya ena kena vakamuri vinaka na kena I vakasala.)
- (B) (Sega) Solia e dua na vuna yavutaki mai na I yaloyalo ni vidio. (O Jonacani e saga me bau wilika o tamana na I vola ni vakasala ni kena tara na teveli.) Ka me vakamuria na I vakasala. Ea vakananumi tamana talega ena ka e a yaco vei Kosta ni a sega ni vakamuria o tamana na I vakasala ni kena tara na trampoline.)
- (C) (Io) Vakamacalataka nomu I sau ni taro ka vakayagataka na I vakaraitaki mai na vidio. (Gone: 1) Na talaidredre vei ira na I tubutubu ena tini ena rarawa. Na nona talaidredre o Salome ki na I vakasala nei Marica me baleta na misini ni vakadodonutaki ulu, ea vakacacana na drau ni uluna ka vakavuna me rairai vakaloloma kina. E vakavuna me vakacacana vakataki koya na marau ni nona siga ni sucu. 2) Na noda yalobe ka nakita me talaidredre sa na vakavuna na kena vakacacani eso na I yaya maroroi. Sa dodonu kina meda vakatutusa ka kere veivosoti ka tovolea me vakavinaka taka na I yaya ka sa vakacacani oya. O Salome e solia na nona I lavo maroroi me laki voli kina e dua na Strawmaker/Covuata vou ka nanuma ni a vakacacana. Tubutubu: 1) Ni da sa kila ga na I tubutubu nida sa cala e matadra na luveda, meda dau vakadodonutaka ka vakatutusa. E vakaraitaka oqori ko Sefa ena nona tusanaka ni a sega ni via vakamuria na I vola dusidusi ni caka teveli. Ea qai bole me bulia e dua na keke me sosomi taka na kena ka vakacacani ka vakadonuya talega me vakamuria na ka e kaya ko Jonacani oya me vakamuria na i tuvatuva ni kena buli e dua na keke. 2) Meda dau totolo ena noda ciqoma ka solia na veivosoti vei ira na luveda. Ena gauna ea vakatutusa kina ko Salome ka kaya me vakayagataki nona sede maroroi me voli kina e dua na misini ni caka ulu vou. O Marica e vakaraitaka na yalo veivosoti ena nona veiwalitaka vei Salome na I rairai ni uluna ka mokoti koya sara ena nona kaya ni a sa ca oti tu ga na misini oya ni se bera nona laki vakayagataka. E kuria o Marica ka kaya ni a vinakata ga me taqomaki koya mai na leqa kei na madua.

Tubutubu kei Gone: Ena vuku ni noda taqomaki raraba, sa dodonu ga meda dau vakayagataka na I vola dusidusi ni yaya vakayagataki se na I yaya eda se qai tara vou tiko. Ko I rau na rua o Sefa kei Jonacani rau a sega ni vakayagataka na I vola dusidusi ka vakavuna me yaco na leqa e na nodratou bula kei na nodratou bula na lewe ni matavuvuale.)

4. OCEI E KAYA? BALETA?



A

"Au na sega ni Draiva
taki kemudrau l
valenibula
ena siga ni sucu nei
Salome."



Marica

B

"Kila na cava? Na tagane
dina ena tukuna
vakadodonu ni sa cala
na ka e cakava."



Sefa

C

"Au a kaya vei iko mo
kakua ni vakayagataka
baleta ni na rawa niko
vakaleqai iko."



Marica

- (A) Marica vei Sefa kei Jonacani ni oti nona vakacalaka taka o Sefa na yava ni teveli, e kaya oya baleta ni kawaii taka nodrau sega ni via vakayagataka na l vola ni vakasala ni caka teveli ka vakavuna na leqa ni vakacalaka e mai yaco.
- (B) Sefa e kila ni kena bale na teveli ka vakacacani na keke ni siga ni sucu nei Salome sa vakavu mai na nona beca ka sega ni via vakamuraia na l vola dusidusi ni caka teveli.
- (C) Marica vei Salome ena gauna ka vakamacalataka kina na vu ni nona sega ni solia na veivakadonui me vakayagataka na misini ni vakadodonu taki drau ni ulu.



"Sa tu vei au na yalo I Jiova. Ni sa lumuti au ko Koya me'u vunautaka na I tukutuku vinaka vei ira era sa dravudravua; me'u vunautaka na sereki vei ira na bobula, kei na rai tale vei ira era sa mataboko. Me'u vakalalagataki ira era sa mavoia ..."

Luke 4:18

Vakasaqara ka wilika na I Vola Tabu

Kevaka ko gadreva me vaikuri taki nomu kila ka

Wilika

Luke 4:16-24 Wilika vaka rua na vei tikina oqo

Toka rua taka na I talanoa

Me dua na lewe ni vuvale me talanoa taka na I talanoa

Veitalanoa ka vakayagataka na vei taro sa toka qori era:

- i. Cava e dua na ka vou ko kunea ena I talanoa/na tikina qo?
- ii. Dua na ka ko kidrowa taka?
- iii. Na cava e sega ni matata vei iko?
- iv. Na cava ko na talairawarawa kina ka bula taka?
- v. Na cava ko na veiwasei taka ena loma ni macawa oqo?

E.G. White Quotes

Ena nona tubu cake ko Jisu, ea vuli mai na vosa ni Kalou. Ena vei siga sa dau vakavulici koya na tinana mai na Vosa ni Kalou kei na nodra I vola vivigi na Parofita. Ena gauna ni nona Cauravou sa dau gole vakamataka ka vaka kina ena vei yakavi me tiko duadua ena ruku ni veikau kei na veidelana me masumasu ka vuli mai na Vosa ni Kalou.” (Education, tabana e. 185)

Na Kalou sa tiko ko ira Nona Digitaki me maroroya ka bulataka na I Vola Tabu kei na kena I vakavuvuli taudua ga. Na I Vola Tabu duadua ga sa I vakatagedegede ni vei vakavuvuli kecega kei na vei mataqali veisau kece ga.(The Great Controversy, tabana e. 595)

E sega tale ni dua na ka e cacakakataki me uasivita na kena vulici na Vosa ni Kalou ni oqori ena vakaukauwa taka na vakasama ka vakabulabula taka na noda kila ka... Kevaka e vulici na Vosa ni Kalou ena kena I vakatagedegede ka dodonu me vakayacori kina, sa na yacova yani na tamata na I vakatagedegede ni vakasama ka cecere kei na I tovo kei na I nakinaki ni bula tudei ka kunekune dredre ena gauna oqo (Christian Education, tabana e. 118)

Sa tu na I sau ni kena vakasaqarai na dina oya ni na dolava na vei ka talei me kunei ka na tevuka tale mai e matada na vei ka uasivi e vuqa me laurai ka vakarabailevu taka na noda kunea na vei lesoni e vuqa mai na I Vola Tabu Oqo na kena veidutaitaki na veitikina me rawa ni taucoko kina na I tukutuku mai na Vosa ni Kalou kei na kena laurai na vei vakasama vaka yalo me veisotari kei na vei vakasama va Kalou mai na Nona vosa. (Christian Education, tabana e. 119)

Sa I ira ga ka gumatua ena vulica na Vosa ni Kalou ka vakila na talei ni kena dina, era na taqomaki mai na veivakacalai kaukauwa ka sa vesuki vuravura tu. Na I vakadinadina ga ni Vosa ni Kalou ena vakila ka kidava na nona I cori ni vakalecececa na meca. (GC tabana e. 625).

“Ko Jisu e sotavi Setani ena vosa ‘Sa sega ni bula na tamata ena madrai duadua ga sa bula ga ena vosa kecega sa lako mai na gusu ni Kalou. (Maciu. 4:4). E na veitemaki kecega e sotava o Jisu sa dau nona I yaragi tu ga na Vosa ni Kalou. (GC tabana e. 625).

“Na I vola oqo e domo ni Kalou ka vosa tiko mai vei keda. Na I volatabu e dolava vei keda na vosa ni bula ka ni vakaveikilaitaki keda kei Karisito ka sa I koya na noda vu ni bula. Meda rawata na vakabauta dina sa dodonu me da kilai Koya ka sa vakadinadinataki tiko qori ena Nona vosa.” (Fundamentals of Christian Education tabana e.433).

Sa ka cecere ka talei sara na I Vola Tabu baleta ni oqori e nona vosa na Kalou bula. Mai vei ira kece na I vola ena vuravura qo, na I vola Tabu sa I vola taudua ka gadreva vakalevu me vulici ka kauwaitaki me vaka ni tiko kina na vuku dina e tawa yalani. (Counsels to Parents, Teachers, and Students, tabana e. 421)

Ni vakayagataki na i Vola Tabu me I vola ni vuli ena solia na yalomatua vua na gone. Na vei lesoni kei na kila ka e rawata na gone mai na I vola oqo ena uasivita na ka e vulici mai na I vola ni science se na I vola ni vuku vakavuravura. Oqo na I vola me vakaivakarautaka ka vakaukauwataka na vakasama, ena cecere ka savasava na I tovo ka na sega ni dua me veiqati kina. (Parents, Teachers, and Students, tabana e. 422)



TUVANAKI I

1. QARA NA VOSA

Vakasaqara na vosa ena vei matanivola oqori:

K T X U C C H A I N S A W N I A H Y K Y M Q B G
 P P A N E Q N T H U A V F A A U L I D M B W Q C
 S C R I P T U R E S U E G N H E B L L J L X I Y
 Q F T O B I X T L C C H N P R O P H E C Y M H D
 G H N F I N D K E Q L K C I U K L R D N N Y G I
 C H A C T S H W I D W Q G O P L X L S H K T E S
 G B J Y F T C W O Q W B G O S P E L S D H E E C
 H K A B C R O A X R B J S B F L U K M D D W Y I
 O H D S R U P L K L D Y W F J R C L Q Q I A T P
 M S W H F C Z O D E E F P X K I V M V S N X T L
 K A D X P T A I P T I T Y A T K M D D Z Y F E E
 I A K I S I P W N G E R T S A T W X V I P K K S
 O N T K U O R R A S T S P E N F W P C N S C M O
 Y H M J K N S Y O E P I T E R L U Q K N R W V W
 A S D T Y S S T O P L I M A D F C S O Z W I M L
 Z P Z O J J D P Y B H A R X M L R I L A M S Y I
 G R Q N B E M R P P T E H E E E T O A N U D I Z
 K I P D K M O G A S M J T L D C N G M R W O G I
 A N E E I T P R E D N T B S U J I T Y G O M W P
 K G N D S J X T L E X I W D R O C K E T O Q V B
 W S W I F T W L E F B H E O I X P V G G P D M U
 G Q H U O E O M N O R D I M B Z H S Z X X J I J
 N P Q Z N U K P W R P Z R A K N C K R Y Y K N Q
 G T R A M P O L I N E O B I R T H D A Y F C O E

Na Vosa me vakayagataki

Allen key	Word	Bible	Scriptures
Disciples	Cake	New Testament	Old Testament
Poetry	Prophecy	Chainsaw	Trampoline
Wisdom	Birthday	Deductions	Inspired
Gospels	Springs	Rocket	Letter from God
Laws	Prophets	Instructions	History
Lipstick			

2. VOSA VEITAKOSVI

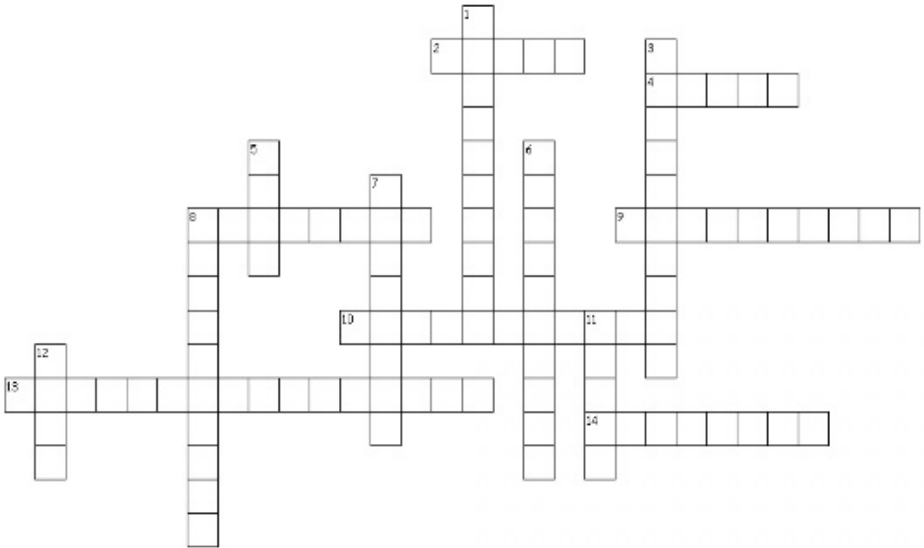

Vosa lako vakanatutu:

- Jonathan lost control of the _____ so the plank of wood hit Sefa's head.
- Salome looked like a _____ with her very bright makeup.
- The setting for this video clip was Salome's _____ party.
- The brand name of the tool Salome used to try and change her hairstyle.
- The type of table that Sefa and Jonathan tried to build without using the Instructions.
- The type of tool Salome asked Marica to use to style her hair.
- Salome put this on her face which made her look like a clown.

Vosa lako sobu:

- Something Sefa built two weeks before, without using the instruction manual.
- Another name for God's Instruction Manual.
- God's Instruction Manual is also called The _____ of God.
- Type of tools Sefa and Jonathan used instead of the Allen Key provided.
- The twins were planning to use their gift to give Salome a _____.
- Another word for instructions which guide you when you build something.
- God's Instruction Manual for our life.
- Marica made and decorated a _____ but it was ruined when the table collapsed.

3. VEIDUTAITAKA

Wilika na tiki ni volatabu ka tiko ena yasana I mawi ka vakasotara vata kei na mata ni vola dodonu ka tiko ena yasana I matau. Oqori na vosa ni yalayala ni Kalou ka solia vei keda mai na Nona vosa.

Bible Texts	Bible Promises
1. <u>Isaiah 54:13</u>	a. <u>Rest when we are tired and have heavy loads to carry.</u>
2. <u>Matthew 11:28</u>	b. <u>Forgiveness when we confess our sins (disobedience).</u>
3. <u>John 14:27</u>	c. <u>Children taught by God and peace given to them.</u>
4. <u>Jeremiah 30:17</u>	d. <u>God will show us remarkable secrets if we call on Him.</u>
5. <u>2 Chronicles 7:14</u>	e. <u>We will have a sense of belonging as God's children that He loves passionately.</u>
6. <u>Jeremiah 33:3</u>	f. <u>Health and healing of our injuries.</u>
7. <u>1 John 3:1</u>	g. <u>Peace so we don't have to worry or be afraid.</u>
8. <u>1 Cor 7:23</u>	h. <u>God will hear our prayers and give healing if we humble ourselves and really seek His will.</u>
9. <u>1 John 1:9</u>	i. <u>God loves us even though we sin (disobey) and showed this when He Jesus to save us.</u>
10. <u>Romans 5:8</u>	j. <u>God paid a high price for us to be saved and set free.</u>



Vakalagilagia na Kalou ena masu ena vuqa na Nona vosa ni yalayala ka tu ena I Vola Tabu. Ka rawa meda ciqoma me noda ena vei gauna dredre eda lako curuma. Kerea Vua na Kalou me vukei iko mo rawa ni dau wilika wasoma Nona vosa me rawa kina niko kunea na Nona I naki ena vukumu kei na veika uasivi e tu me baleta nomu bula.

4. GAUNISALA BASOGA

Droinitaka se tabaka e dua na sala me tekivu mai cake me yaco sara e loma donu.

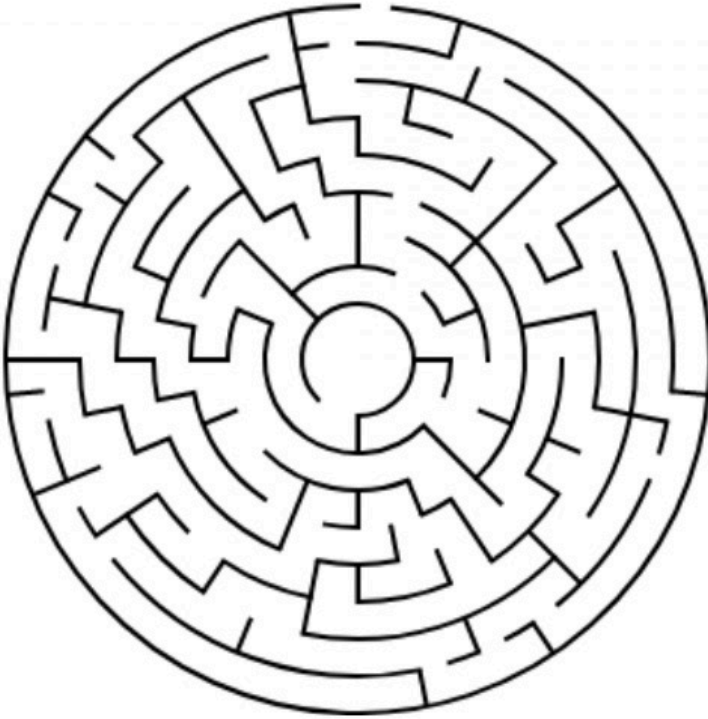

Masu ni sa oti nomu droini ka vakavinavinaka Vua na Kalou ena Nona solia na I Vola Tabu me rawa ni ko valamuria na veigaunisala ni bula. Vakavinavinaka taka na veivakasala e vuqa ka tu ena nona vosa meda muria me rawa kina na bula marau!

5. YACA NI VOLA TABU VUNITAKI

Sega soti ni dredre.

Vakasaqara e 16 na yaca ni I vola mai na I Vola Tabu ka vunitaka tu ena I talanoa ka volai toka oqori e ra? Toqa wavokita na yaca ni I Vola niko sa kunea.

I once made a remark about the hidden books of the Bible (merely by a fluke). It kept people looking so hard for the facts and for others it was a revelation. Some were in a jam, especially since the name of the books were not capitalized, but the truth finally struck home to numbers of readers. To others it was a real job. We want it to be a most fascinating few moments for you. Yes, there will be some really easy ones to spot. Others may require judges to help them. I will quickly admit it usually takes a minister to find one of them, and there will be loud lamentations when it is found. A little lady says she brews a cup of tea so she can concentrate better. See how well you can compete. Relax now. There really are sixteen names of books in this story.

Oqo ena dredre vakalailai

E rawa niko kunea e 30 na I vola mai na I Vola Tabu ena I talanoa? Toqa wavoki na yaca ena gauna ko sa kunea kina.

Me veivuke: 10 vei ira e kunei rawarawa ia na 20 tale e sa volai toka oqori e ra na yacadra.

- | | |
|------------|--------------|
| 1. Hebrews | 11. James |
| 2. Romans | 12. Ruth |
| 3. Hosea | 13. Kings. |
| 4. Numbers | 14. Titus |
| 5. Mark | 15. Peter |
| 6. Matthew | 16. Amos |
| 7. Malachi | 17. Genesis |
| 8. Joel | 18. Philemon |
| 9. Esther | 19. Luke |
| 10. Acts | 20. Nahum |

E 30 na I vola ni I Vola Tabu e tiko ena I talanoa oqo. Tovolea mo vakasaqarai ira kece mada:

This is almost remarkable puzzle. It was found by a gentleman in an airplane seat pocket, on a flight from Los Angeles to Honolulu, keeping him occupied for hours. He enjoyed it so much, he passed it on to some friends. One friend from Illinois worked on this while fishing from his john boat. Another friend studied it while playing his banjo. Elaine Taylor, a columnist friend, was so intrigued by it she mentioned it in her weekly newspaper column. Another friend judges the job of solving this puzzle so involving, she brews a cup of tea to help her nerves.

There will be some names that are really easy to spot. That's a fact. Some people, however, will soon find themselves in a jam especially since the book names are not necessarily capitalized.

Truthfully, from answers we get, we are forced to admit it usually takes a minister or a scholar to see some of them at the worst. Research has shown that something in our genes is responsible for the difficulty we have in seeing the books in this paragraph. During a recent fund raising event, which featured this puzzle, the Alpha Delta Phi lemonade booth set a new record. The local paper, The Chronicle, surveyed over 200 patrons who reported that this puzzle was one of the most difficult they had ever seen. As Daniel Humanahumbly puts it, "The books are all right here in plain view hidden from sight." Those able to find all of them will hear great lamentations from those who have to be shown. One revelation that may help is that books like Timothy and Samuel may occur without their numbers. Also, keep in mind, that punctuation and spaces in the middle are normal. A chipper attitude will help you competereally well against those who claim to know the answers. Remember, there is no need for a mad exodus; there really are 30 books of the Bible lurking somewhere in this paragraph waiting to be found. God Bless.

Source: <http://home.snu.edu/~hculbert/hidden.html>



Masu ka kerea Vua na Kalou me vukei iko mo rawa ni dau taleitaka na wilika na Vosa ni Kalou. Mo vakayacora oqori ena vei siga ka tovolea mo biuta vakatikitiki e 30 na miniti ena veisiga mo wilika kina na Vosa ni Kalou. Me rawa niko raica kina na veika me baleta na noda Kalou.

BOLEBOLE NI MATAVUVALE

(Digitaka e 1 se 2 mo dou vakayacora vaka matavuvale ena macawa oqo)

► Dou vakayagataka na qito mai na I Vola Tabu se Bible quiz games e na nomudou lotu vakavuvale. Oqo eso na kena I vakaraitaki:

- i. **Bible charades/ Pictionary** - Na kena vakamatanataka na vosa - Me ra volai na pepa na vei vosa kece mai na dua na tiki ni vola tabu. Se talanoa. (1 Me volai e yadua na vosa ki na dua na tiki ni pepa.). Digitaka e dua me vakamatanataka na vosa ka volai tiko ena tiki ni pepa. -oya na kena qito taki na charade E dua tale oya me tabaka se droini taka eso na yaloyalo se I vakatakarakara me tukuna na I balebale ni vosa. Oqo na kena qito taki na Pictionary Na vo ni matavuvale me ratou vakarau me tukuna se vakilakila na cava e vakamatanataka tiko se droinitaki tiko ya. Na I kuri ni vakamacala ena kune ena website oqo: - <https://youthministry.org.au/2009/03/17/bible-charadespictionary>
- ii. **Bible Taboo** - Mo dou wilika vata e dua na tikina se I talanoa mai na I Vola Tabu. O Iko na iTubutubu- Mo vakarautaka taumada eso na cards (kati ni qito) mo digitaka eso na vosa mai na I talanoa se tiki ni vola tabu mo dou na vakayagataka ena qito. Vola na vosa digitaki ena dua na card. E na ruku ni

vosa oya, vola kina e lima tale na veivosa ka tabu me vakayagataki ena gauna dou sa vakilakila tiko kina na vosa digitaki. Na vo ni vuvale mo dou qai vakacavuta na vei vosa ka nuitaki nina dua e cavuta donu na vosa ka sagai tiko me kilai oya.

Na kena vakarautaki na qito

e tarava: Me ra vakaitavi na gone qase cake ena kena vakarautaki na kati se cards ni vosa me vakayagataki ena tikina se talanoa ka tarava. Na website ka koto oqori e tiko kina na I vakamacala e so ena kena caka na cards kei na kena qito taki na Bible Taboo.

<https://youthministry.org.au/2009/03/15/bible-taboo/>

- iii. **Vakilakila se Ko Cei qo?** Oqo na qito me caka ni sa oti kena wiliki na veitalanoa eso mai na I vola tabu ena loma ni macawa. Mo vakarautaka e rua na I binibini cards lalai (kati). Me volai ena tiki ni kati e cake na yaca kei na veika eso me baleti koya me vaka: Tagane se yalewa, Bula ena gauna ni veiyalayalati makawa se veiyalayalati vou, na yacana, yaca ni Vola mai na I volatabu ka kune kina na I talanoa, Parofita se Tamata vuku, tamata vinaka se tamata ca, kawa vaka tui se dauveiqaravi.

Na kati ni qito me digitaki ga mai na dua na I tuvatuva kati.

Na I karua ni tuvatuva kati me ra vakadavori ena buturara ni qito me raica kece na lewe ni qito na ka e volai tiko ena kati.

Na vo ni vuvale me ra vakaraica na kati sa tuvani tu ena floor ka Vakataroga eso na taro me qai sauma mai o koya ka taura tiko na kati digitaki ena nona kaya "IO" ke donu se "SEGA" ke cala. ' Kena I vakaraitaki oqo - "Ko tagane beka?" se " O iko tamata vinaka?" Se " Iko Parofita?" O koya ga e cavuta donu na yaca ka vica wale sara na taro e taroga sa nona na qaqa ena qito.

Kevaka dou matavuvale levu, sa rawa ni wase vakarua na matailawalawa ni qito. Ka vakalailaitaki sobu na taro me tau ya 10 ga. Oqori me vukea na kena vakasamataki vinaka na taro me tarogi. Na website se link ka soli tiko oqori era sa tiko kina na I vakamacala kei na kati vakarautaki ka rawa ni tabaki mo dou vakayagataka.

<https://youthministry.org.au/2010/06/23/guess-who-bible-characters/>

Na link ka toka oqo era sa rawa ni kune kina eso tale na qito me vakayagataki.

<https://youthministry.org.au/category/bible-games/>

- Vakavulici iratou na gone se vakatovotovo taka na vei gaunisala ni vuli vola tabu eso me rawa ni titobu nodratou kila na vosa ni Kalou. (Sa rawa ni vakayagataki na vei tiki ni vola tabu mai na lesoni ni Wilivola vaka Siga Tabu. each and

model for your children

A) ACRONYMS - Oqo na kena vakayagataki na mata ni vola yadua ni dua na vosa me vaka I balebale taka e dua na ka me caka. -dou vakayagataka na acronym oqori mo dou veitarogi taka na tiki ni Vola Tabu ka vakasaqaqara kina me vulica na tikina digitaki.

(i) S.P.E.C.K - Sin to avoid or confess, Promise to claim, Example to follow, Command to obey and Knowledge of God to acquire. Na I vakamacala kei na I lavelave ka rawa ni tabaki sa tiko ena link oqo: <https://gleneyrie.org/wp-content/uploads/2018/04/SPECK-Bible-Study-Tool-1.pdf>

ii) S.P.A.C.E. - Sins to Confess, Promises to Claim, Attitudes or Actions to Adopt or Avoid, Commands to Obey, Examples to Follow.

iii) S.O.A.P - Scripture, Observations, Application, Prayer (Explained in 'Lome Likes' Worship booklet).

iv) A.P.P.L.E - **A**tttributes of God, **P**romises of God, **P**inciples for Life, **L**esson Learned, **E**xample to Follow.

The following link provides further explanations: <https://arabahjoy.com/apple-bible-study-method/>

v) S.P.E.C.S.A.P - **S**ins, attitudes or actions to forsake; **P**romises - assurance or benefit for us to claim from God; **E**xamples - good attitudes to take from the verse; **C**ommands - directions from

God; **S**tumbling blocks - things God warns us to avoid; **A**ctions - what we need to apply in our lives; **P**rayer - pray that God will help us to walk faithfully with God.

- Mala ni vosa/Ulutaga taumada: Me digitaki e dua na vosa se ulutaga dou taleitaka se gadreva me vulica ka vakayagataka na I vukevuke ni vuli vola tabu vaka na Bible Concordance me rawa ni raici mai kina na vei tiki ni volatabu tale eso ka salavata se tukuni tiko ena nomudou ulutaga digitaki. Dou raica se I vakamacala cava e tukuni me baleta nomudou ulutaga. Kevaka e tiko na internet dou raica na website oqo me vakasaqarai kina na vosa se ulutaga dou digitaka. www.biblegateway.com Ni sa taipa taki ga na vosa se ulutaga sa na solia tale ga mai na internet na vei tiki ni vola tabu ka rawa ni kune kina na vosa dou digitaka kei na I vakavakadewa e vakayagataki.. E rawa talega ni google taki ga nomu taro ena google search me vaka oqo: "Bible texts about..."Sa rawa talega ni vakayagataki na link oqo me biuta vata mai na vei tiki ni vola tabu ka salavata kei na ulutaga se vosa ko solia yani me vaqarai. <https://www.openbible.info/topics/>

Oqo e dua na link ka rawa ni vakayagataki me solia na veitiki ni vola tabu tale eso ka tautauvata se tukutuku tautauvata kei na kena dou vulica tiko: <https://www.openbible.info/labs/cross-references/>

E so tale na veigaunisala ni vuli vola tabu sa rawa ni kune na vei link oqo: <https://embracingthelovely.com/creative-bible-study-methods/#Unique> [Creative Methods of Bible Study](https://www.biblestudytools.com/blogs/chris-russell/5-great-ways-to-study-your-bible.html) <https://www.biblestudytools.com/blogs/chris-russell/5-great-ways-to-study-your-bible.html>

Na gaunisala cava ga ko digitaka mo dou vakayagataka vaka matavuvale, sa na uasivi ka dodonu mo kila vinaka ka vakatovolea mo qitora ni se bera ni ko vakavulica vei iratou na lewe ni matavuvale.

Ena uasivi sara me volai ena journal se dua na I vola (exercise book) na vuli dou vakayacora. Oqori mo dou na qai dau rai lesuva ena gauna mai muri se mo vakayagataka ena gauna ko kacivi kina me veiwasei ena lotu se soqoni ni vuli vola tabu e vale ni lotu se vanua ni cakacaka.

Vei ira na gone ka se sega ni rawa ni wilivola sa tu e vuqa na I talanoa mai na I vola tabu ka rawa ni laurai ena You Tube ka ra sa katoni tu ena vidio clip.

Oqo eso na link mo dou raica ka tekivu kina: <https://www.youtube.com/watch?v=onnEalNBaGg> - Na I talanoa kei Noa."The Beginner's Bible" <https://www.youtube.com>

[watch?v=wmio42mjcls](https://www.youtube.com/watch?v=wmio42mjcls) - Talanoa ni Siga ni Sucu Part 1 by "The Beginner's Bible"
<https://www.youtube.com/watch?v=aGVfqiyyOOI> - Taniela
<https://www.youtube.com/watch?v=UszC5Z2hxmI> - Come Follow me by Living Scriptures. Oqo na clip ka tukuna nona kacivi ratou nona Tisaepeli o Jisu.
<https://www.youtube.com/watch?v=5UNBtaVsWm4> - "Roar" by Super book. E wasea na I talanoa kei Taniela ena qara ni laione ia e vakayagataki tiko kina na vakasama ni gauna qo.

- Mo kunea eso na vei gaunisala ni kena vulici na yaca ni vei vola ena I vola tabu kei na kena cavuta vaka veitarataravi. So tale na I vukevuke ni vuli e tiko ena links oqori:

<https://www.youtube.com/watch?v=uPmifDA1ak0>
<https://www.youtube.com/watch?v=LuyEryHeB6U>
<https://www.youtube.com/watch?v=NhV8XwiOsNA>

i) Kena vakayagataki na sere-

<https://www.youtube.com/watch?v=KLZvdafKKTE>

ii) Oqo na I vola mai na I vola tabu kei na kena I vakamacala.

<https://www.youtube.com/watch?v=Z9vhK9tk9ME> -Vei yalalati Makawa

<https://www.youtube.com/watch?v=JlwISkR4-pM> - Veiyalalati

Vou.

<https://www.youtube.com/watch?v=wZVrc-Mjxr0> - Vei yalalati vou kei na veiyalalati Makawa.

Sa rawa ni dou bulia na qaqa ni sere kei na kena vakamatanataki. Sa rawa talega niko wasea nomu sere oqori ena nodratou website na "The Tuis Facebook" me rawa ni ra raica talega na veimatavuvale ka vakayagataka. Cavuqaqa taka na vei wiligusu ka vakayagataki tu ena I vola oqo se na kena ka sa digitaka nomu matavuvale mo dou vulica ena macawa oqo. Dou vakayagataka na kena ka vakatokai na: "The Word of God, ka me vakayagataki na "Rebus Verse."

Na kena I vakamacala ni itaviqaravi na 'Rebus Verse'

Na veika e gadrevi:

- Pepa
- Peni kau
- Peni kei na pental pen se markers
- So na stickers se na clip art ka tabaki me vakayagataki

I Vakasala ni kena vakayagataki:

1. Me caka na Rebus ena kena veisosomitaki eso na vosa I yaloyalo se na vei tikina ka vakayagataki kina na I yaloyalo Oqo e yaga vei ira na gone lalai kei ira era sega ni kila na wili vola. Era na raica na I yaloyalo ka vuli mai kina. Vakasaqara na

vosa ka rawa me veisosomitaki ena stickers se na I yaloyalo.

2. Vukei ira na gone me ra vola na tiki ni Vola Tabu me vulici. Vakagalala taka tiko e dua na tikina ena ruku ni wiligusu me droinitaki kina na kena I yaloyalo ke gadrevi se veiganiti kei na tiki ni Vola Tabu.
3. Me ra vakabi stickers se I yaloyalo lalai na gone ena veivanua lala ena I talanoa se tiki ni Vola Tabu.

Vukevuke tale eso

- Me taba (print) rawa na I lavelave ni tiki ni Vola Tabu ka tiko na kena vanua lala me ra vakabira kina na gone na I yaloyalo ka salavata kei na wiligusu se tiki ni Vola Tabu. Me soli vei ira nodra cakacaka me kauta I vale.
- Me caka eso na vei tiki ni Vola Tabu me Rebus ka me ra qai biuta vata na gone e dua na I vola me maroroi kina na nodra wiligusu ka caka tu me Rebus. Oqori mera qai dau vakawilika ena nodra gauna galala.
- Ko ira na gone qase cake sa rawa ni droini taka ga vakai ira nodra I yaloyalo ena vanua lala ena nodra tini ni Vola Tabu vakarautaki.

Digitaka mai na veitaro oqo na kena mo dou vakayagataka ena nomudou gauna ni lotu vaka matavuvale. Ena uasivi talega mo dou bulia ga nomudou taro me salavata kei na vei tikina dou vulica tiko vakamatavuvale.

1. Niko se gone, ko bau dau rerevaka na butobuto? Baleta na cava?
2. Na cava beka e kaya kina ko Tevita ni cina e rarama ni nona gaunisala?
3. Na cava beka nomu nanuma e vakavuna me ra vakatabuya eso na vei matanitu me vakacurumi yani ena nodra vanua na I Vola Tabu?
4. Na I talanoa cava beka ko dau taleitaka mai na I Vola Tabu? Na cava e tara na lomamu mai na tikina oqori?
5. Na cava eso tale na ka ko rawa ni cavuqaqa taka ka sega ni bau dau taura na gauna na kena vulici?
6. Na cava eso na ka e vaka taotaka tu nomu wilika na Vosa ni Kalou? Ko na veisau taka beka vakacava oqori?
7. Ko sa bau vola oti e dua na I vola vua e dua ko lomana vakalevu? (Nomu daulomani beka) Cava e yacovi iko ena nomu raica ni sega ni kauwaitaka o koya nomu I vola ka sega ni via wilika?
8. E tiko beka e dua na nomu I Vola Tabu? Ko dau taura na gauna mo wilika?
9. Na veigaunisala cava ko vakayagataka me cavuqaqa taka kina na vei tiki ni Vola Tabu?

(Na veitaro oqori e tauri mai na I vola (Connecting with God 28 Ways: Children's Evangelism Series pp 13-14)



Wilika na masu oqo ka yavutaka mai kina e dua nomu masu vakataki iko. Mo masu ena nomu vakayagataka ga na nomu vosa vaka I taukei. "Vinaka vakalevu Jisu na nomu digitaka mo vosa vei au e veisiga. . Au na vakasaqara na Nomuni Vosa mai na noqu I Vola Tabu ena gauna au rogoca kina na kemuni I talanoa mai Koronivuli se e vale ni lotu. Au gadreva me nomu I tokani nikua ka me tawa mudu. Emeni"



NA SERE

"God's book, the Bible" ratou vakarautaka na Abide Ministry. Oqo e dua na disc ka salavata kei na itaviqaravi na "Connecting with God 28 ways".

Oqo na qaqa ni sere: "God's book, the Bible"

Verse 1

If you want to read a letter that will help you to live better
Then you've gotta read God's book the Bible (3x)
So stop and read
'Cause it's just what you need
Go and read God's Holy Bible

Verse 2

It's got a story or two and shows you what you should do
When you read God's Holy Bible 3x
So stop and read
'Cause it's just what you need
Go and read God's Holy Bible

Verse 3

It's full of good advice that will help you with your life
So stop and read God's Holy Bible 3x
So stop and read
'Cause it's just what you need
Go and read God's Holy Bible

- Growing up with Jesus" Sere mai na DVD. It's song 1 on the Arnie's Shack DVD ka salavata kei na itaviqaravi na Connecting with God 28 ways" resource.

Sere tale eso mai na You Tube a na rawa ni kune ena mataveilawa oqo:

- <https://www.youtube.com/watch?v=4BFGWuXUdhY>
- "2 Timoci 3:16 All Scripture"
- <https://www.youtube.com/watch?v=-dcsR8bslUM&list>
- "The B.I.B.L.E" sere vaka I vukivuki
- <https://www.youtube.com/watch?v=QnUWGjMu9XQ&list>
- "The B.I.B.L.E" "
- <https://www.youtube.com/watch?v=uBoHpeHFR-w>
- "If you want to be wise".
- <https://www.youtube.com/watch?v=senuUz-j9zA> - "God's Word is the Bible"
- <https://www.youtube.com/watch?v=W8cJQMU9Q-U&list>
- "Word of God speak".

- <https://www.youtube.com/watch?v=FS1LAc5DSCU>
- "Thy Word is a lamp".
- <https://www.youtube.com/watch?v=Afz0q0cQjll>
- "They Word is a lamp".
- <https://www.youtube.com/watch?v=3vmTkXNpwzs&list>
- "Ancient Words".
- <https://www.youtube.com/watch?v=0oiQfMQebW8>
- "Ancient Words".
- https://www.youtube.com/watch?v=eP9D4xcw_U0
- "Every promise in the Book is mine".
- <https://www.youtube.com/watch?v=K9DodTRI3vU>
- "The books of the Bible"
- <https://www.youtube.com/watch?v=PYRyJxs9CG4&list>
- "Read your Bible pray everyday".
- <https://www.youtube.com/watch?v=l0PNiGP0lpk>
- "Wonderful Words of life".
- <https://www.youtube.com/watch?v=AwdhimkaTgQ>
- "Every time I read my Bible".
- <https://www.youtube.com/watch?v=p6-KKBxaFJk&list> - "Living Word".
- <https://www.youtube.com/watch?v=0DpSlliWkEM&list>
- "Every promise in Your Word".
- <https://www.youtube.com/watch?v=KqaA8XB15o&list>
- "Your Words".
- <https://www.youtube.com/watch?v=ubRIJj8xkds&list>
- "Speak, O Lord".

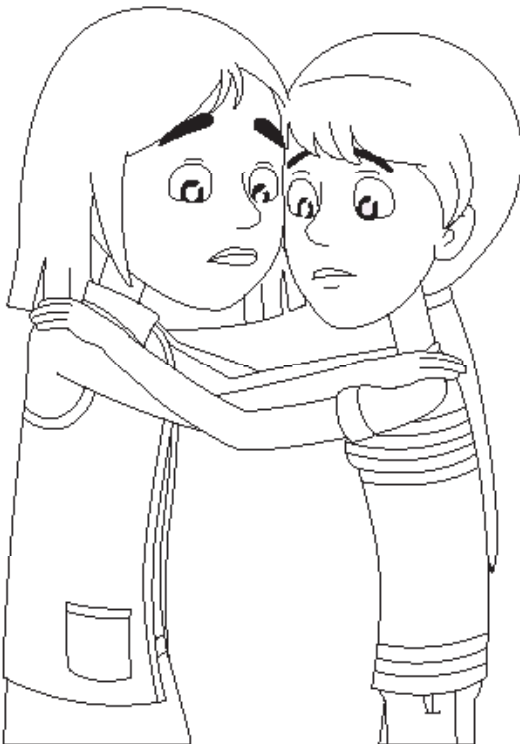

- <https://www.youtube.com/watch?v=fCSYiGEOOaE&list>
- "Your Words of Life".
- <https://www.youtube.com/watch?v=xQmj1RVA6XA>
- "The Word of God".





I SAU NI TARO

1. Qara na vosa

K T X U C **C H A I N S A W** N I **A** H Y K Y M Q R G
 P P A N E Q N I H U A V F A A U **L** I D M B W Q C
S C R I P T U R E S U E G N H E B **L** J L X I Y
 Q F T O B **I** X T L C C H N **P R O P H E C Y** M H **D**
 G H N F I N D K E Q L K C I U K L R D **N** N Y G **I**
 C H A C T **S** H **W** I D W Q G O P L X L S H **K** T E **S**
 G B J Y F **I** C W **D** Q W B **G O S P E L S** D H **E E**
 H K A B C R **O** A X R B J S B F L U **K** M D D W **Y** **I**
 O H D **S** R **L** P **I** **K** **L** D Y W F J R **C** I Q Q I A T **F**
 M S **W** H F **C** Z G **D** **E** **E** F P X **K** **I** V M V S N X T **E**
 K **A** D X P **I** A **I** P **T** **I** **T** **Y** A **T** K M D D Z Y F **E** **E**
L A K L S **I** **E** W **N** G **E** R **I** S A T W X V I P K K **S**
 O N T K U **R** R A S **T** S **F** E N F W P C N **S** C M O
 Y I I M J K **N** S Y **O** **E** **F** **I** **T** **E** R L U Q K **N** R **W** V W
 A **S** D I Y **S** S I **O** **L** **L** **I** M A D **F** C S **O** Z W **I** M L
 Z **I** Z O J J D **P** **Y** B **H** A R X M L R **I** L A M S **Y** I
 G R Q N B E M R P **P** **T** **E** H **E** **E** **E** **T** O A N U **D** I Z
 K **I** P D K M **O** G A S M J **I** **L** **D** **C** N **G** M R W **G** I
 A **N** E E **L** **I** P R E D N T **E** S U J I **T** **Y** **G** O M W P
 K **G** N D **S** J X **T** I E X **I** W **D** R O **C** K E **T** O Q V B
 W **S** W **I** F **I** W **L** E F **B** H **E** O I X P V G G P **D** M U
 G Q **H** U O **E** O M N O R **D** I M B Z H S Z X X J I J
 N P Q Z **N** U K P W R P Z R A K N C K R Y Y K N Q
G **T** **R** **A** **M** **P** **O** **L** **I** **N** **E** **O** **B** **I** **R** **T** **H** **D** **A** **Y** **F** **C** **O** **E**

2. Veidutaitaka

Solution for the Match Up Puzzle

Bible Texts	Bible Promises
1. c Isaiah 54:13	a. Rest when were are tired and have heavy loads to carry
2. a Matthew 11:28	b. Forgiveness when we confess our sins (disobedience)
3. g John 14:27	c. Children taught by God and peace given to them.
4. f Jeremiah 30:17	d. God will show us remarkable secrets if we call on Him.
5. h 2 Chronicles 7:14	e. We will have a sense of belonging as God's children that He loves passionately.
6. d Jeremiah 33:3	f. Health and healing of our injuries
7. e 1 John 3:1	g. Peace so we don't have to worry or be afraid
8. j 1 Cor 7:23	h. God will hear our prayers and give healing if we humble ourselves and really seek His will/ways.
9. b 1 John 1:9	i. God loves us even though we sin (disobey) and showed this when He Jesus to save us.
10. i Romans 5:8	j. God paid a high price for us to be saved and set free.

I SAU NI TARO

3. Vosatakoso

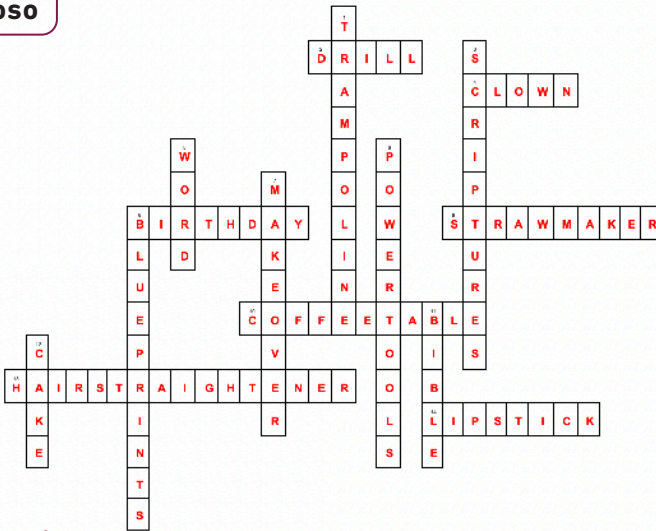

Vosa lako vakanatutu:

2. Jonathan lost control of the **DRILL** so the plank of wood hit Sefa' head.
4. Salome looked like a **CLOWN** with her very bright makeup.
8. The setting for this video clip was Salome's **BIRTHDAY** party.
9. The brand name of the tool Salome used to try and change her hairstyle. **STRAWMAKER**
10. The type of table that Sefa and Jonathan tried to build without using the Instructions. **COFFEE**
13. The type of tool Salome asked Marica to use to style her hair. **HAIR STRAIGHTENER**
14. Salome put this on her face which made her look like a clown. **LIPSTICK**

Vosa lako sobu:

1. Something Sefa built 2 weeks before, without using the instruction manual. **TRAMPOLINE**
3. Another name for God's Instruction Manual. **SCRIPTURES**
5. God's Instruction Manual is also called **The WORD** of God.
6. Type of tools Sefa and Jonathan used instead of the Allen Key provided. **POWERTOOLS**
7. The twins were planning to use their gift to give Salome a **MAKEOVER**.
8. Another word for instructions which guide you when we build something. **BLUEPRINTS**
11. God's Instruction Manual for our life. **BIBLE**
12. Marica made and decorated a **CAKE** but it was ruined when the table collapsed.

4. Sala Basoga

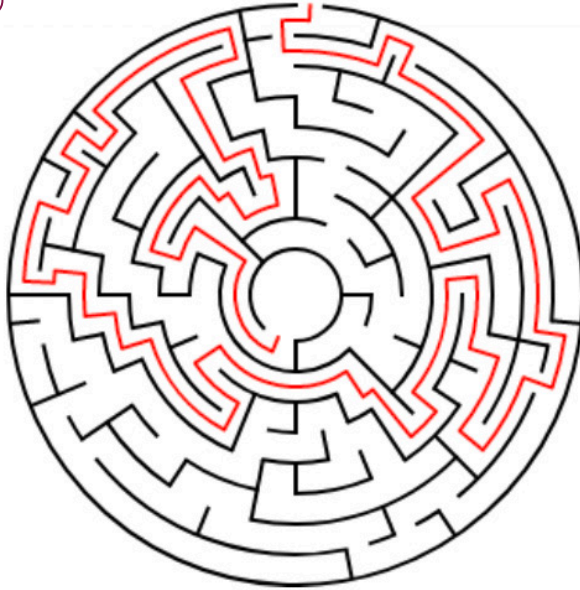

5. Yaca ni Vola Tavu Vunitaki

Iwali ni yaca ni ivola ni iVolatabu sa vunitaki (Sega soti ni veibolei)

I one made a re**mark** about the hidden books of the Bible (merely by a **fluke**). It kept people look**ing** so hard for the **facts** and for others it was a **revelation**. **S**ome were in a **jam**, especially since the name of the books were not capitalized, but the **truth** finally struck home to **numbers** of readers. To others it was a **real** job. We want it to be **a most** fascinating few moments for you. **Yes, there** will be some really easy ones to spot. Others may require **judges** to help them. I will quickly admit **it usually** takes a minister to find one of them, and there will be loud **lamentations** when it is found. A little lady says **she brews** a cup of tea so she can concentrate better. See how well you can com**pete**. **R**elax now. There really are sixteen names of books in this story.

Source: <http://home.snu.edu/~hculbert/solution.html>

Iwali ni yaca ni ivola ni iVolatabu sa vunitaki (Veibolei vakalevu cake)

There are 30 books of the Bible in this paragraph. Can you find them? This is a most remarkable puzzle. It was found by a gentleman in an airplane seat pocket, on a flight from Los Angeles to Honolulu, keeping him occupied for hours. He enjoyed it so much, he passed it on to some friends. One friend from Illinois worked on this while fishing from his John boat. Another friend studied it while playing his banjo. Elaine Taylor, a columnist friend, was so intrigued by it she mentioned it in her weekly newspaper column. Another friend judges the job of solving this puzzle so involving, she brews a cup of tea to help her nerves. There will be some names that are really easy to spot. That's a fact. Some people, however, will soon find themselves in a jam, especially since the book names are not necessarily capitalized. Truthfully, from answers we get, we are forced to admit it usually takes a minister or a scholar to see some of them at the worst. Research has shown that something in our genes is responsible for the difficulty we have in seeing the books in this paragraph. During a recent fund raising event, which featured this puzzle, the Alpha Delta Phi lemonade booth set a new record. The local paper, The Chronicle, surveyed over 200 patrons who reported that this puzzle was one of the most difficult they had ever seen. As Daniel Humana humbly puts it, "The books are all right here in plain view hidden from sight." Those able to find all of them will hear great lamentations from those who have to be shown. One revelation that may help is that books like Timothy and Samuel may occur without their numbers. Also, keep in mind, that punctuation and spaces in the middle are normal. A chipper attitude will help you compete really well against those who claim to know the answers. Remember, there is no need for a mad exodus; there really are 30 books of the Bible lurking somewhere in this paragraph waiting to be found. God Bless.

Ivurevure: <http://home.snu.edu/~hculbert/answer.html>



Seventh-day
Adventist Church

South Pacific

Copyright 2019 by
Discipleship Ministries – Children’s Ministries,
South Pacific Division of the Seventh-day
Adventist Church

E vola ko: Sarai Vaofanua-Stephens
E tabaka ko: Litiana Rakarakatia Turner
Discipleship Ministry Daunivakasala: Leigh Rice
Droinitaka ko: Mark Aitken & Garth Tudor
Vakadewataka o: Fulori Sususewa Bola
Veiliutaki kei sekeriteri: Alexandra Manners

